

ADDENDUM/ADENDO/NACHTRAG/ APPENDICE/APÉNDICE/ADDENDUM

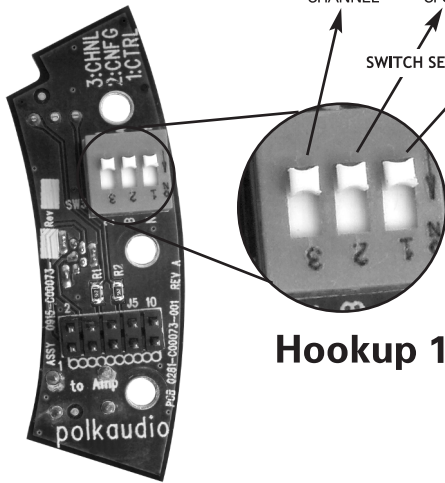

This Hookup Guide Supersedes the LCi-IP Owner's Manual.
 Este manual de conexão substitui o Manual do Proprietário da LCi-IP.
 Diese Anschlussanleitung löst das LCi-IP-Benutzerhandbuch ab.
 Questa guida al collegamento sostituisce il manuale dell'utente di LCi-IP.
 Esta Guía de conexión revoca el Manual del propietario de LCi-IP.
 Ce guide de connexion remplace le guide de connexion du manuel de l'utilisateur LCi-IP.

Hookup 1a: NETWORK PAIR (Control on Left)

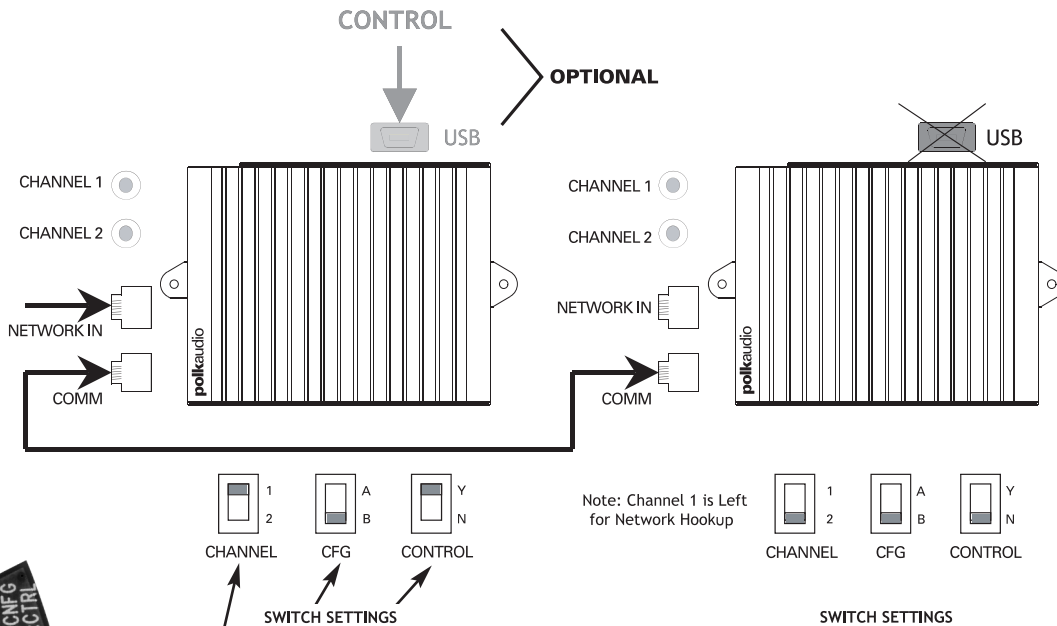

Hookup 1b: NETWORK PAIR (Control on Right)

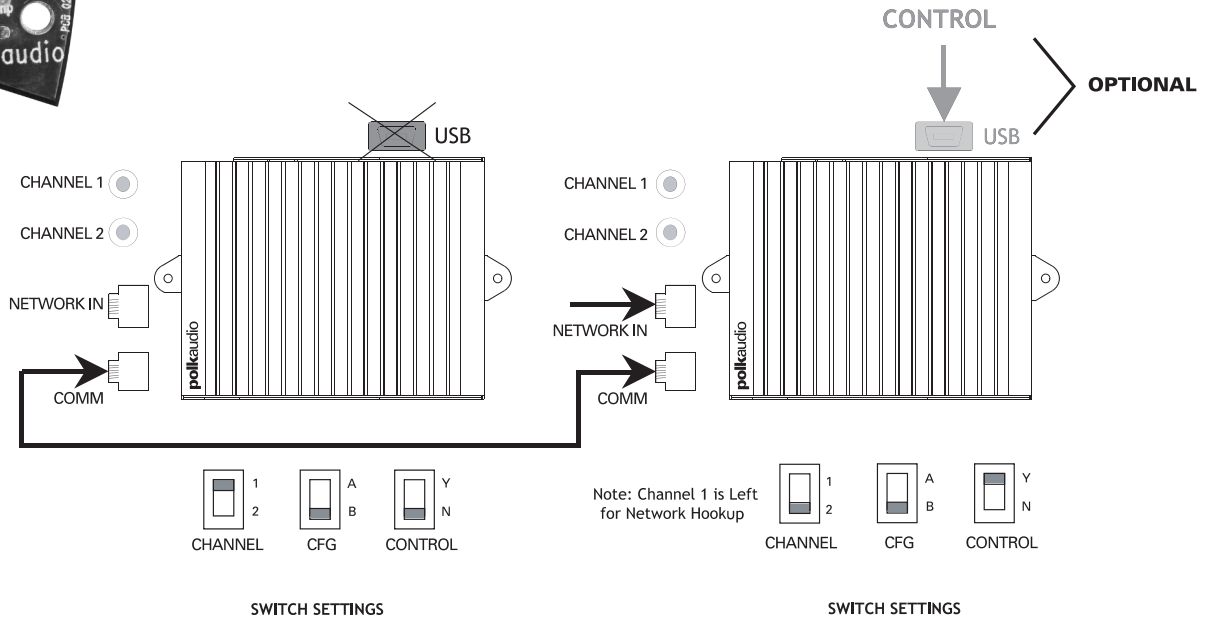

Hookup 2: NETWORK (Independent Control)

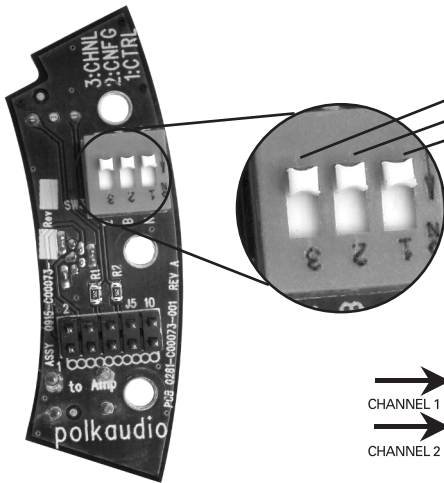
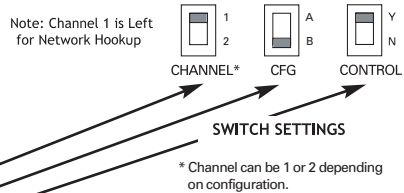
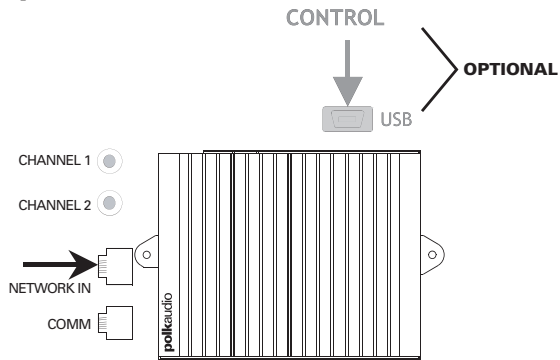

Hookup 3a: ANALOG PAIR (Control on Left)

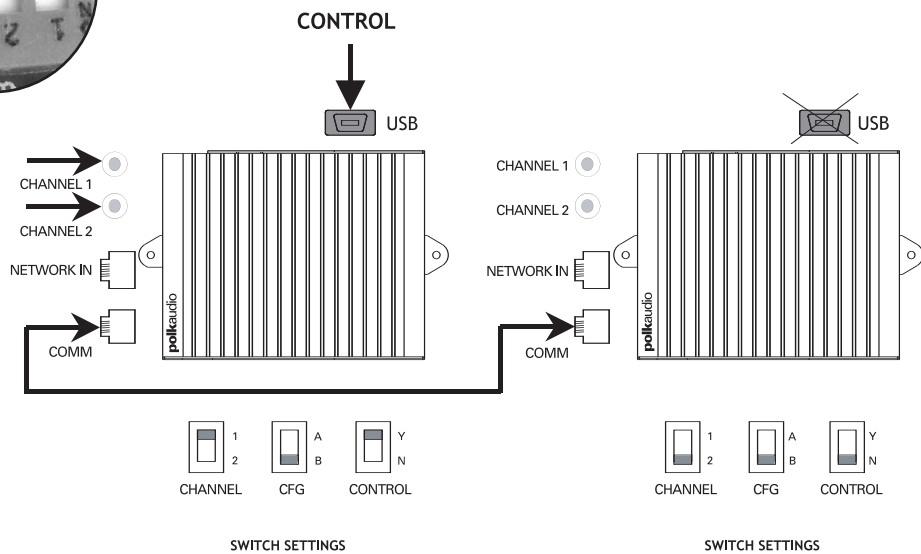

Hookup 3b: ANALOG PAIR (Control on Right)

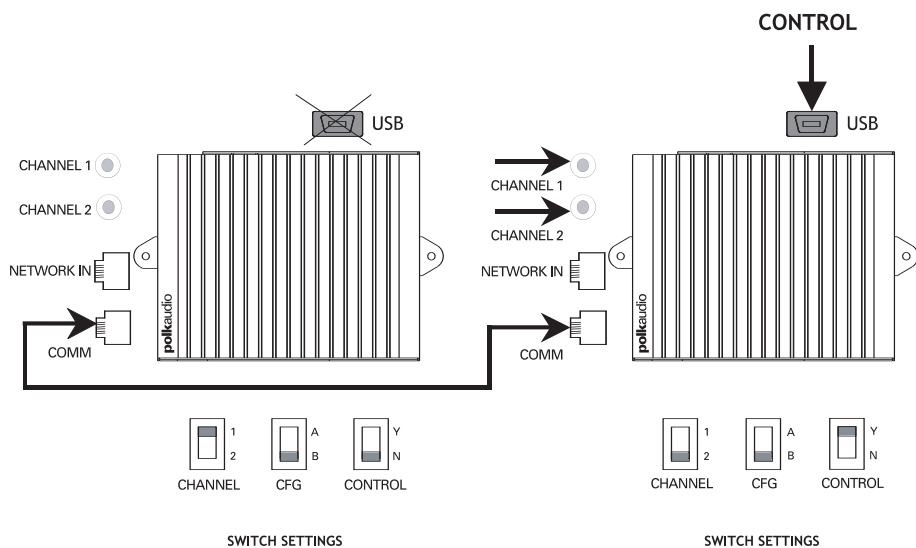

Hookup 4a: ANALOG PAIR (Control on Left)

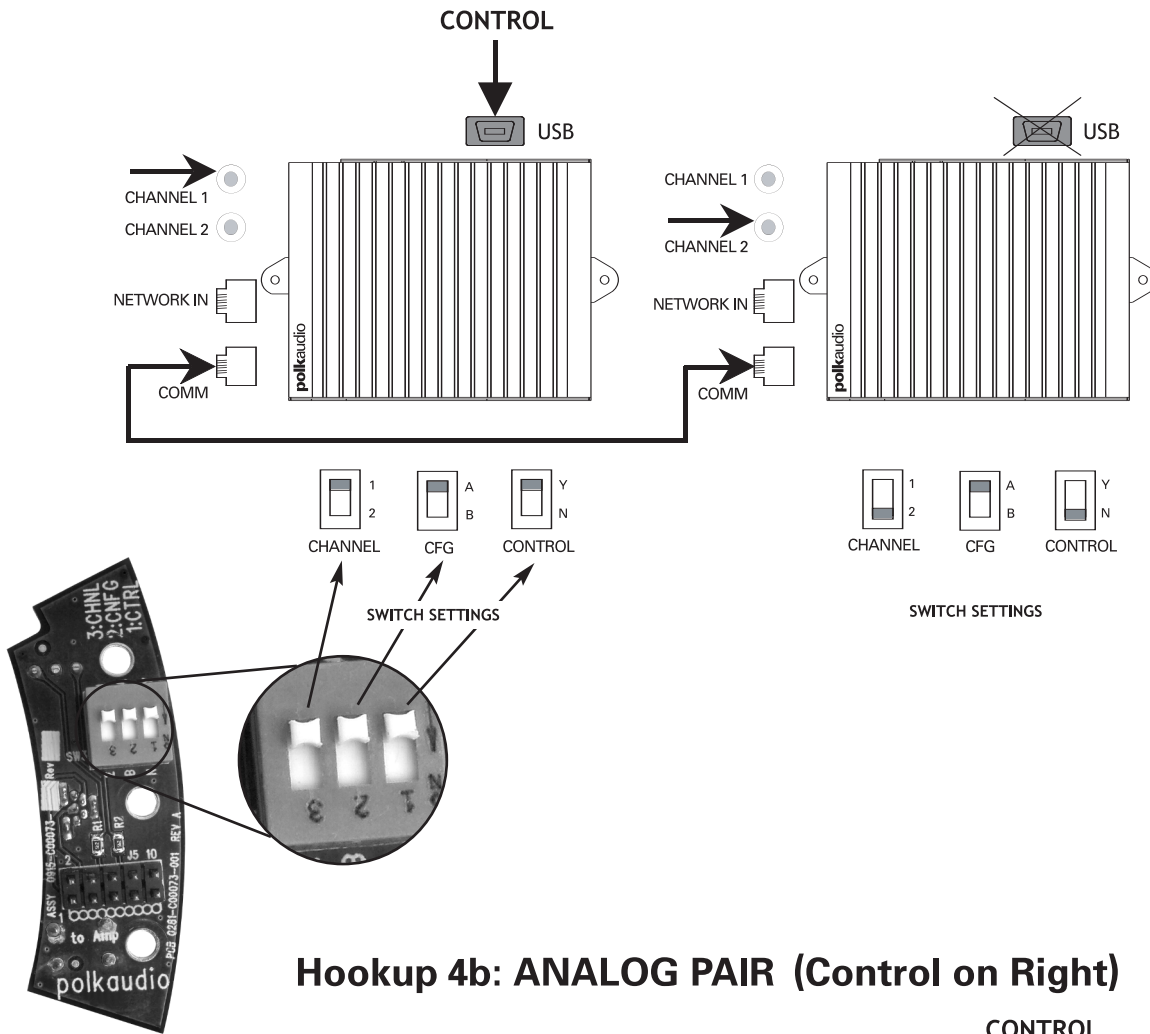

Hookup 4b: ANALOG PAIR (Control on Right)

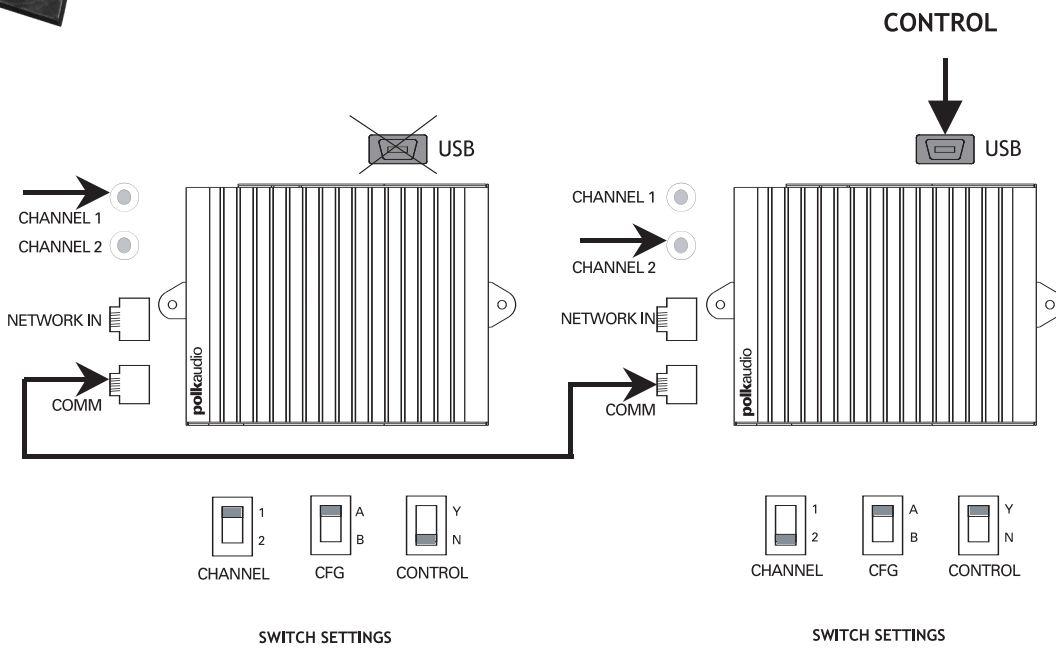

CENTER CHANNEL

Hookup 5a: ANALOG (Independent Control When Used with Hookup 3a or 3b)

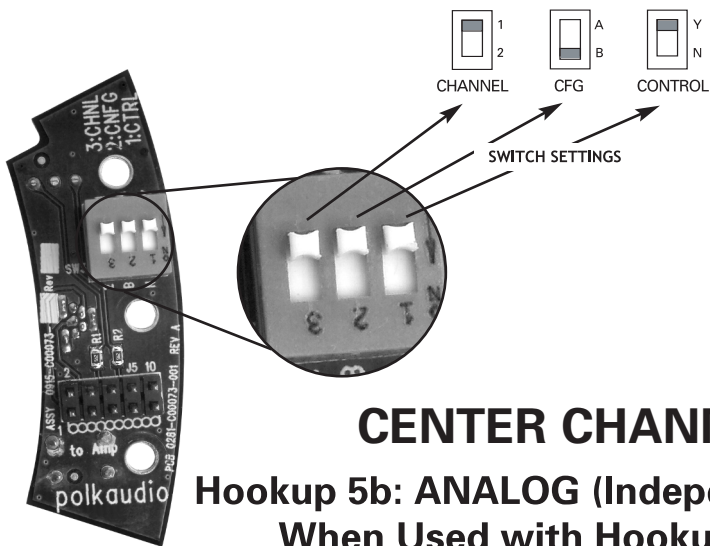
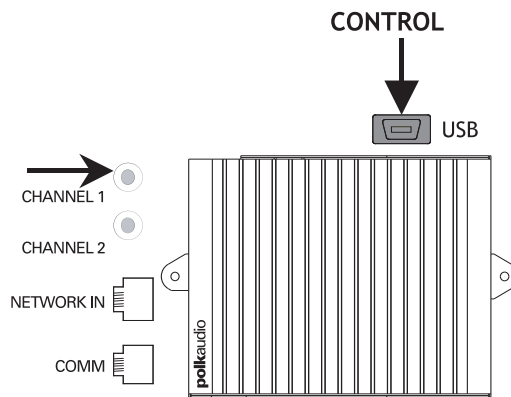

CENTER CHANNEL

Hookup 5b: ANALOG (Independent Control When Used with Hookup 4a or 4b)

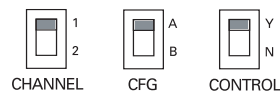
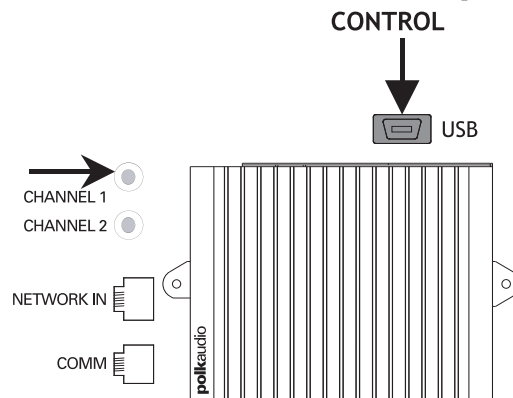

SWITCH SETTINGS