

CSi20

CSi30

CSi40

Center Channel Loudspeakers

FXi30

FXi50

Surround FX Loudspeakers

**Owner's
Manual**

polkaudio
the speaker specialists®

POLK AUDIO HISTORY—A PASSION FOR SOUND

Polk Audio was founded in Baltimore in 1972 by Johns Hopkins University graduates Matthew Polk and George Klopfer. Today, Polk Audio is a leading international manufacturer of high quality home, car and multimedia loudspeakers. Polk products emphasize superior sound and build quality, and feature many patented and award-winning innovations. Polk Audio has built a reputation as “The Speaker Specialists.” Polk products are sold throughout the USA, Canada and in over 50 countries around the world. Polk Audio’s mission has always been to build high quality, great sounding speakers at affordable prices. For the people of Polk Audio, building speakers is not just a job; it’s a *passion*.

PLACEMENT RECOMMENDATIONS FOR THE CSi SERIES CENTER CHANNEL LOUDSPEAKER

The CSi Series Center Channel Loudspeaker incorporates the most effective magnetic shielding available so it can be placed safely on or near your TV or video monitor. If you notice video distortion or discoloration, immediately move the speaker away from the TV and call Polk Audio Customer Service 800-377-7655 (9AM to 6PM EST, US or Canada) or polkcs@polkaudio.com. The most popular placement for a center channel speaker is on top of your TV, anchoring the dialogue and effects to the screen [figure 1]. An alternate placement is on a shelf below your TV [figure 1]. If you are using a front projection TV system, place the center channel speaker on a small stand or table immediately below the bottom of the projection screen, or at ear level behind the screen if your screen is acoustically transparent. Consult the owner’s manual for your screen. Adhesive rubber feet are included with your CSi Center Channel Loudspeaker and may be attached to the bottom of the speaker to protect your furniture and keep the speaker in place.

PROCESSOR MODE CONFIGURATION FOR THE CSi SERIES CENTER CHANNEL LOUDSPEAKER

The “bass management” or “speaker configuration” menus of most surround receivers offer the choice of “normal” or “wide” modes for center channel operation. In discrete channel digital processors these modes are referred to as “small” and “large.” Normal (small) mode filters bass frequencies from the center channel speaker and sends them instead to the front left & right main speakers or to the subwoofer output (LFE) jack. Wide (large) mode sends an unfiltered, full range signal to the center channel speaker. Use the Small (normal) mode for optimum center (and surround) channel performance and reliability.

PLACEMENT AND BI-POLE/DI-POLE OPERATION OF FXi SERIES SURROUND FX LOUDSPEAKERS

The FXi Series Surround FX Loudspeakers were designed to provide the ultimate diffuse sound field experience in your home theater system. One FXi speaker is the “left” channel speaker, and the other is the “right” channel speaker. The serial number label identifies which speaker is which [figure 2]. The “left” surround speaker should be placed on the left side of the room *as you face the front of the room*. The type of surround processor you use will influence your placement and bi-pole/di-pole switching choices [figure 2]. Experiment to find the right balance of sound quality and room integration:

Direct surround effects—bi-pole mode [figure 3a & 3b]: If you plan on placing the speakers more than one foot (30cm) behind the primary listening position we recommend using the “bipole” switch setting [figure 2] and placement.

FIGURE 1

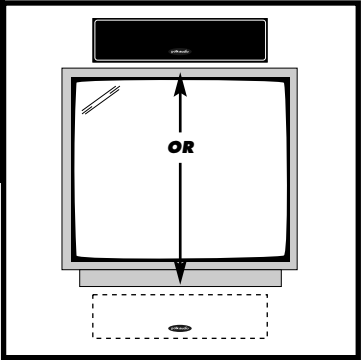

FIGURE 1

Most popular placement, above the TV screen. CSi Series Center Speakers are magnetically shielded for safe placement near TV or video monitors. If you notice video distortion or discoloration, immediately move the speakers away from the video source and call Polk Audio Customer Service 800.377.7655 (US and Canada) or polkcs@polkaudio.com.

La ubicación más común es encima de la pantalla del televisor. Los altavoces centrales de la serie CSi tienen blindaje magnético para poder ubicarlos con seguridad cerca de monitores de televisión o de video. Si nota que hay distorsión o descoloración de la imagen, aleje inmediatamente los altavoces de la fuente de video y comuníquese con el servicio al cliente de Polk Audio.

Disposition la plus courante, au-dessus de l'écran. Les enceintes de la série CSi sont blindées magnétiquement et peuvent être disposées à proximité d'une télé ou d'un moniteur vidéo. Si vous percevez de la distorsion ou de la décoloration vidéo, éloignez immédiatement les enceintes de l'écran et communiquez avec le service à la clientèle de Polk.

Häufigste Platzierung – über dem Fernsehbildschirm. CSi-Mittenslautsprecher sind für eine Platzierung in der Nähe von Fernsehgeräten oder Videomonitoren magnetisch abgeschirmt. Wenn Sie eine Verzerrung oder Verfärbung des Videobildes bemerken, sind die Lautsprecher umgehend von der Videoquelle zu entfernen. Setzen Sie sich in diesem Fall mit dem Kundendienst von Polk Audio in Verbindung.

FIGURE 2

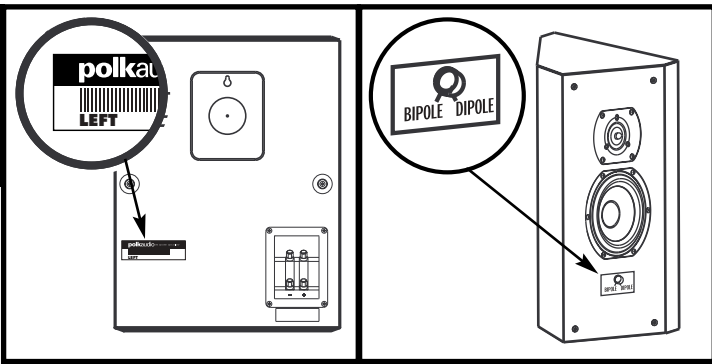

FIGURE 2

Consult serial number label for correct FX speaker orientation. Note location of Bipole/Dipole switch.

Consulte la etiqueta con el número de serie para orientar correctamente el altavoz.

Pour orienter vos enceintes f/x correctement, consultez l'étiquette du numéro de série (et non celle de l'interrupteur Bipole/Dipole).

Angaben zur ordnungsgemäßen Ausrichtung der Lautsprecher finden Sie auf dem Typenschild mit der Seriennummer.

FIGURE 3

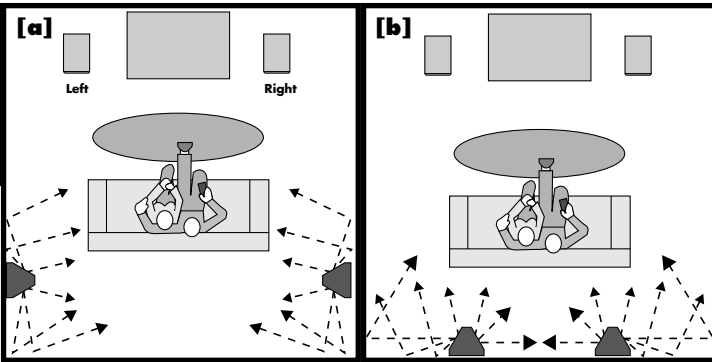

FIGURES 3a & b

Direct surround effects using BI-POLE mode.

Set Surrounds as "small" in your receiver's Bass Management settings.

Efectos de sonido surround directo con modalidad BI-POLE.

Asigne la clasificación "pequeño" a los altavoces surround en los parámetros de control de bajas frecuencias de su receptor.

Efectos de sonido surround directo con modalidad BI-POLE.

Asigne la clasificación "pequeño" a los altavoces surround en los parámetros de control de bajas frecuencias de su receptor.

Pour des effets ambiophoniques directionnels, choisissez le mode BI-POLE. Réglez le contrôle "surround" de votre récepteur à "small".

Pour des effets ambiophoniques directionnels, choisissez le mode BI-POLE. Réglez le contrôle "surround" de votre récepteur à "small".

Direkte Surround-Effekte im BIPOL-Modus. Stellen Sie die Surround-Werte der Tiefen auf Ihrem Empfänger auf "klein" ein.

Direkte Surround-Effekte im BIPOL-Modus. Stellen Sie die Surround-Werte der Tiefen auf Ihrem Empfänger auf "klein" ein.

Diffuse surround effects—di-pole mode **[figure 4]**: For a more diffuse effect, place the speakers on the side walls in line with your listening position and at least 2 feet away from the rear wall. Select the “dipole” switch setting **[figure 2]**.

Processor Mode Configuration for the FXi Series Surround FX Loudspeaker: Set Surrounds to “Small” in your receiver’s Bass Management settings.

CONNECTING YOUR LOUDSPEAKERS [FIGURES 5 & 6]

We recommend 16-gauge or larger speaker wire. Follow the hookup directions included with your receiver. Strip 1/2 inch (12.7mm) of insulation from each of the two conductors of the wire to expose the bare metal and twist each of the individual conductors into single unfrayed strands. Note that one of the terminals on the rear of each speaker is red (+) and the other is black (-). Make certain that you connect the wire from the red (+) terminal of your amplifier or receiver to the red (+) terminal on your speaker and the wire from the black (-) terminal of your amplifier or receiver to the black (-) terminal on your speaker. Most wire has some indicator (such as color-coding, ribbing or writing) on one of the two conductors to help you maintain consistency.

To connect wire to the binding post **[figure 7]**, unscrew the hex nut and insert the bare wire into the hole near the base of the binding post. Do not insert the insulated part of the wire into the hole as this will not give you a good connection. Twist the hex nut back down the binding post until it firmly meets the wire. Do not over tighten.

To use Banana Plugs (US only): Unscrew the binding post lug nuts completely to expose the binding post plugs (plastic plugs inserted into the binding posts). Carefully pry out the binding post plugs to expose banana plug holes. Screw the lug nuts back on the binding posts and insert banana plugs. (This is for US owners only.)

BI-WIRING OR BI-AMPING THE CSi40

If you decide to bi-wire or bi-amp, you must remove the flat metal jumpers between terminal posts. Failure to do this could result in damage to your amplifier and loudspeakers.

Bi-wiring [figure 8] can provide noticeable improvements in the overall transparency of your loudspeakers. Run separate speaker wires to the low and high frequency drivers from a single amplifier: after removing the jumpers, connect one set of speaker wires to the upper terminals on each speaker and one set of (usually heavier gauge) wires to the lower terminals. Connect the other ends of both wire sets to the corresponding amplifier outputs.

FOR MANUAL UPDATES, VISIT

<http://www.polkaudio.com/home/library/manuals.php>

FOR MORE DETAILED HOOK UP AND PLACEMENT INFORMATION, VISIT

<http://www.polkaudio.com/home/faqad/>

FOR RECOMMENDED ACCESSORIES (INCLUDING SPEAKER STANDS, BRACKETS AND EXCLUSIVE POLK AUDIO LOGOWEAR), VISIT OUR WEBSTORE:

<http://shop.polkaudio.com/>

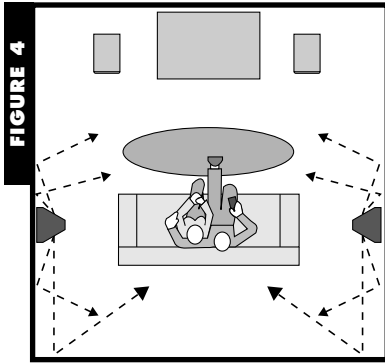

FIGURE 4

FIGURE 4
 Diffuse surround effects using DI-POLE mode.
 Set Surrounds as "small" in your receiver's Bass Management settings.

Efectos de sonido surround difuso con modalidad DI-POLE. Asigne la clasificación "pequeño" a los altavoces surround en los parámetros de control de bajas frecuencias de su receptor.

Pour des effets ambiophoniques diffus, choisissez le mode DI-POLE. Réglez le contrôle "surround" de votre récepteur à "small".

Surround-Effekte lassen sich im DIPOL-Modus verteilen. Stellen Sie die Surround-Werte der Tiefen auf Ihrem Empfänger auf "klein" ein.

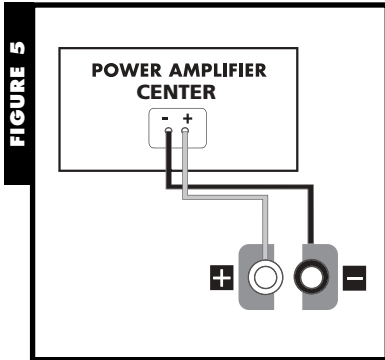

FIGURE 5

FIGURE 5
 Basic Center Channel Speaker hookup diagram.
 Set Center Channel to "small" in your receiver's Bass Management settings.

Diagrama básico de conexión.

Diagramme de branchement rudimentaire.

Grundlegendes Anschlussdiagramm.

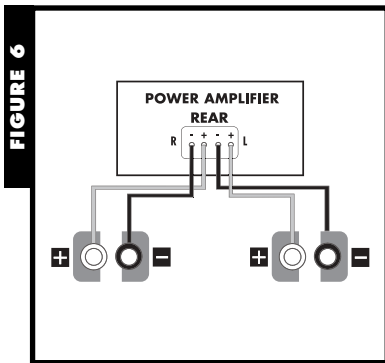

FIGURE 6

FIGURE 6
 Basic Surround FX Speaker hookup diagram.
 Set Surrounds to "small" in your receiver's Bass Management settings.

Diagrama básico de conexión.

Diagramme de branchement des enceintes f/x ambiophoniques. Réglez le contrôle des canaux ambiophoniques de votre récepteur à "small."

Grundlegendes Anschlussdiagramm.

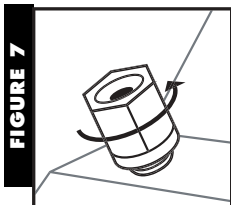
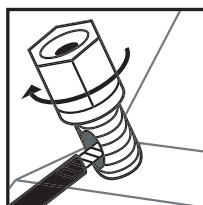
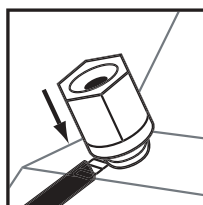

FIGURE 7

Loosen hex nut
 Desenrosque parcialmente la tuerca hexagonal
 Desserrer l'écrou
 Sechskantmutter lösen



Insert speaker wire through hole
 Inserte el alambre para la bocina en el orificio
 Insérer le fil du haut-parleur dans le trou
 Lautsprecher-Draht durch das Loch schieben



Tighten hex nut
 Enrosque la tuerca de nuevo
 Serrer l'écrou
 Sechskantmutter festschrauben

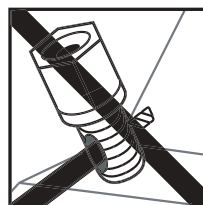

Do not insert insulated section of speaker wire
 No inserte alambre con material aislante
 Ne pas insérer la partie isolée du fil du haut-parleur
 Isolation des Lautsprecher-Drahtes nicht in das Loch schieben

FIGURE 7
 Using binding post connections.

Uso de conexiones con tornillos de presión.

Utilisation des bornes de branchement.

Verwendung von Anschlussklemmen.

To use Banana Plugs (US only):
 Unscrew the binding post lug nuts completely to expose the binding post plugs (plastic plugs inserted into the binding posts). Carefully pry out the binding post plugs to expose banana plug holes. Screw the lug nuts back on the binding posts and insert banana plugs.
 (This is for US owners only.)

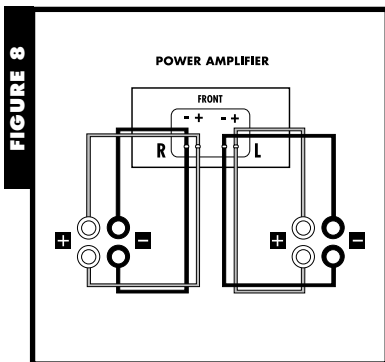

FIGURE 8

FIGURE 8 [CSi40 ONLY]
 Bi-wiring, or using separate speaker wire connections for high and low frequency sections.

Bicableado, o uso de conexiones de cables de altavoz separadas para las secciones de alta y baja frecuencia.

Bi-câblage: l'utilisation de câbles distincts pour brancher les composants des hautes et des basses fréquences de vos enceintes.

Verwendung von unterschiedlichen Kabelverbindungen für hohe und niedrige Frequenzen.

Bi-amping [figure 9] allows you to use separate amplifiers for the high and low frequency sections of your loudspeaker for greater dynamic range and lower distortion. After removing the jumpers, connect the speaker wires from the high frequency amplifier outputs to the upper set of terminal posts on each speaker. Follow the same procedure for connecting the low frequency amplifier outputs to the lower set of terminals. Remember to maintain correct wiring polarity (+ to +, - to -) in all connections.

WALL MOUNTING THE FXi SERIES SURROUND LOUDSPEAKER

The FX Series Surround Loudspeakers feature built-in wall mounting brackets. Follow the steps below to safely wall mount these speakers. Wall mounting requires basic skills in with tools such as a drill and a screwdriver. If you are in doubt that you possess the necessary skills or tools, consult your Polk Audio dealer, or a professional installer.

- Make sure the material on which you plan to mount the speakers (plaster, drywall, paneling, stone, etc.) can support the weight of the speakers (FXi30=approx 13lbs/5.9kg ea., FXi50=approx 15.5lbs/7kg ea.). Make sure the locations you select do not conceal electrical wiring or plumbing.
- Prior to installation, hold the speaker in the chosen location to make sure it safely clears obstacles such as ceiling, adjacent walls, corners, beams, lighting fixtures and door/window frames.
- Using the keyhole slots in the bracket template (included), mark the installation location of the four keyhole slots with a pencil **[figure 10]**. Orient the template so that the small ends of the keyhole slots are facing “up.”
- If you are certain that there is a stud behind the wall surface, drive a #10 screw (*not included*) through the wall and into the stud **[figure 11a]**.
- If there is no stud behind the wall at the chosen location, install a #10 wall anchor (*not supplied*) into the wall by following the wall-anchor-manufacturer’s instructions **[figure 11b]**.
- For masonry walls, use a masonry drill bit and #10 masonry anchor and screw (*not included*).
- Tighten screws into stud or wall anchors, leaving screw heads protruding 1/16” (1.6mm).
- Make all wire attachments now. (*See previous page.*)
- Line up the keyhole slots on the back of the speakers so that the screw heads pass through the large center hole of the slots.
- Let the speaker and slide straight down, allowing the screw head to slip behind the smaller end of the keyhole slot **[figure 12]**.
- Tug gently on the speaker to make certain that the screws and bracket are properly aligned and that the wall anchors are secure.
- If the bracket is not held snug against the wall by the screw heads, remove the speaker from the wall, drive the screws in a little further and then remount the speaker.

SAFE LIMITS OF OPERATION

Your Polk loudspeakers are made with the highest quality materials for years of trouble-free performance. However, damage to loudspeakers can occur when an amplifier, regardless of its wattage, is made to play at higher listening levels than its power can clearly produce (usually beyond the “1 to 2 o’clock” position on the volume control). This results in very high levels of audible distortion, originating in the amplifier, that can add a harsh, gritty sound to music. Contrary to popular belief, a speaker is more likely to be damaged by trying to get too much volume from a low-powered amp or receiver than from a high powered one.

TAKING CARE OF YOUR LOUDSPEAKERS

Your new Loudspeakers are constructed of a rugged material that can be dusted or cleaned with a damp cloth. Avoid harsh detergents and cleaning fluids, as they can permanently damage your speakers’ finish **[figure 13]**. Vacuum the grilles to remove dust.

FIGURE 9

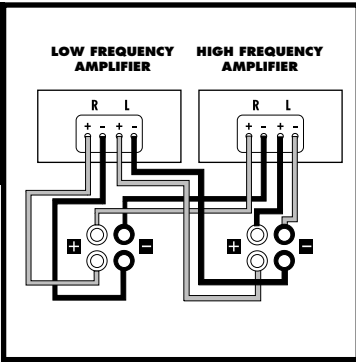

FIGURE 9

Bi-amping, or using separate amplifiers for the low and high frequency sections of your speakers.

Bi-amplificación, o uso de amplificadores separados para las secciones de baja y alta frecuencia de los altavoces.

Bi-amplification: l'utilisation d'amplis distincts pour alimenter les composants des hautes et des basses fréquences de vos enceintes.

Verwendung von unterschiedlichen Verstärkern für niedrige und hohe Frequenzen der Lautsprecher.

FIGURE 10

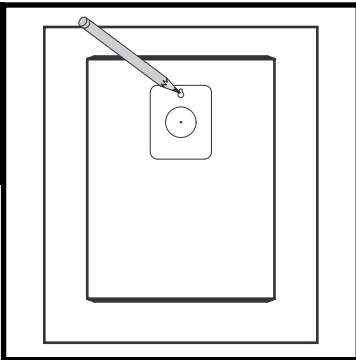

FIGURE 10

Use template to mark mounting location.

Use la plantilla para marcar la ubicación de montaje.

Utilisez le gabarit pour marquer le lieu de fixation.

Verwenden Sie die Schablone zur Markierung der Befestigungsstelle.

FIGURE 11

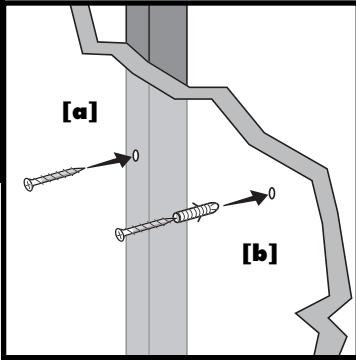

FIGURE 11a & 11b

Use #10 screw for wall stud, use #10 wall anchors + screw for no wall stud.

Use un tornillo n° 10 si hay parales internos en la pared, use anclas de pared n° 10 y un tornillo si no hay.

Utilisez des vis #10 pour fixation sur montant ou des chevilles d'ancrage #10 avec vis s'il n'y a pas de montant.

Verwenden Sie eine Schraube (Nr. 10) für Wände mit Holzstielverstärkung bzw. Dübel und Schrauben (Nr. 10) für Wände ohne Holzstielverstärkung.

FIGURE 12

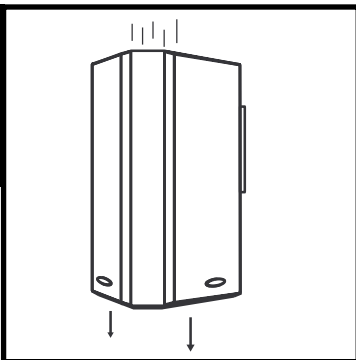

FIGURE 12

Slide the speaker down on the screw heads to catch the keyhole slots.

Deslice el altavoz hacia abajo sobre las cabezas de los tornillos para que entren en las ranuras en forma de cerradura.

Glissez l'enceinte sur les têtes de vis jusqu'à ce que les encoches en trou de serrure s'enclenchent.

Schieben Sie den Lautsprecher auf die Schraubköpfe herunter, so dass sie in den Ritzen einrastet.

FIGURE 13

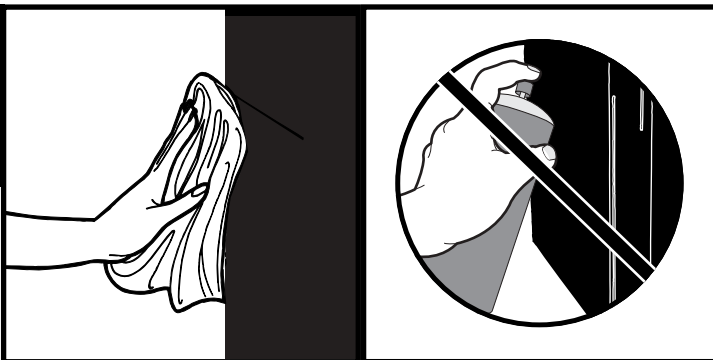

FIGURE 13

Do not use furniture polish on veneer. Clean veneer with a damp cloth.

Cuidado del acabado de madera natural.

Entretien de la finition en bois véritable.

Pflege der Holzappretur.

LIMITED FIVE YEAR WARRANTY

Polk Audio, Inc. warrants to the original purchaser only that this Polk Audio Loudspeaker Product (the "Product") will be free from defects in materials and workmanship for a period of five (5) years from the date of original retail purchase from a Polk Audio Authorized Dealer. However, this Warranty will automatically terminate prior to the expiration of the five (5) years if the original retail purchaser sells or otherwise transfers the Product to any other party. The original retail purchaser shall hereinafter be referred to as "you." To allow Polk Audio to offer the best possible warranty service, please fill out the Product Registration Card(s) and send it to the Factory, at the address provided on the Product Cards(s) within ten (10) days of the date of purchase.

Defective Products must be shipped, together with proof of purchase, prepaid insured to the Polk Audio Authorized Dealer from whom you purchased the Product, or to the Factory at 2550 Britannia Boulevard, Suite D, San Diego, California 92154. Products must be shipped in the original shipping container or its equivalent; in any case the risk of loss or damage in transit is to be borne by you. If upon examination at the Factory or Polk Audio Authorized Dealer it is determined that the unit was defective in materials or workmanship at any time during this Warranty period, Polk Audio or the Polk Audio Authorized Dealer will, at its option, repair or replace this Product at no additional charge, except as set forth below. All replaced parts and Products become the property of Polk Audio. Products replaced or repaired under this warranty will be returned to you, within a reasonable time, freight prepaid.

This warranty does not include service or parts to repair damage caused by accident, disaster, misuse, abuse, negligence, inadequate packing or shipping procedures, commercial use, voltage inputs in excess of the rated maximum of the unit, cosmetic appearance of cabinetry not directly attributable to defect in materials or workmanship, or service, repair, or modification of the Product which has not been authorized or approved by Polk Audio. This warranty shall terminate if the Serial number on the Product has been removed, tampered with or defaced.

This warranty is in lieu of all other expressed Warranties. If this Product is defective in materials or workmanship as warranted above, your sole remedy shall be repair or replacement as provided above. In no event will Polk Audio, Inc. be liable to you for any incidental or consequential damages arising out of the use or inability to use the Product, even if Polk Audio, Inc. or a Polk Audio Authorized Dealer has been advised of the possibility of such damages, or for any claim by any other party. Some states do not allow the exclusion or limitation of consequential damages, so the above limitation and exclusion may not apply to you.

All implied warranties on this Product are limited to the duration of this expressed Warranty. Some states do not allow limitation on how long an implied Warranty lasts, so the above limitations may not apply to you. This Warranty gives you specific legal rights, and you also may have other rights which vary from state to state.

This Warranty applies only to Products purchased in the United States of America, its possessions, and U.S. and NATO armed forces exchanges and audio clubs. The Warranty terms and conditions applicable to Products purchased in other countries are available from the Polk Audio Authorized Distributors in such countries.

SPECIFICATIONS

CSi40

DRIVER COMPLEMENT:

2 - 6½"(16.5cm) drivers
1"(2.5cm) tweeter

OVERALL

FREQUENCY RESPONSE:

40Hz-27kHz

-3DB LIMITS:

50Hz-26kHz

RECOMMENDED

AMPLIFICATION:

10-250 watts/channel

EFFICIENCY (1M, 1W):

91dB

IMPEDANCE:

Compatible with 8 Ohm Outputs

CROSSOVER FREQUENCY:

2.5kHz

CROSSOVER SLOPE:

2nd Order HP,
2nd Order LP

ENCLOSURE TYPE:

PowerPort

DIMENSIONS:

7½"H x 22¾"W x 12½"D
(19.1cmH x 57.5cmW x 31.8cmD)

SHIPPING WEIGHT:

28 lbs (12.7kg)

CSi30

DRIVER COMPLEMENT:

2 - 5¼"(13.3cm) drivers
1"(2.5cm) tweeter

OVERALL

FREQUENCY RESPONSE:

52Hz-27kHz

-3DB LIMITS:

55Hz-26kHz

RECOMMENDED

AMPLIFICATION:

10-180 watts/channel

EFFICIENCY (1M, 1W):

90dB

IMPEDANCE:

Compatible with 8 Ohm Outputs

CROSSOVER FREQUENCY:

2.5kHz

CROSSOVER SLOPE:

2nd Order HP,
2nd Order LP

ENCLOSURE TYPE:

Ported

DIMENSIONS:

6½"H x 20"W x 7¾"D
(16.5cmH x 50.8cmW x 18.7cmD)

SHIPPING WEIGHT:

19 lbs (8.6kg)

CSi20

DRIVER COMPLEMENT:

5¼"(13.3cm) drivers
¾"(1.9cm) tweeter

OVERALL

FREQUENCY RESPONSE:

55Hz-22kHz

-3DB LIMITS:

60Hz-20kHz

RECOMMENDED

AMPLIFICATION:

10-100 watts/channel

EFFICIENCY (1M, 1W):

89dB

IMPEDANCE:

Compatible with 8 Ohm Outputs

CROSSOVER FREQUENCY:

3.6kHz

CROSSOVER SLOPE:

2nd Order HP,
1st Order LP

ENCLOSURE TYPE:

Ported

DIMENSIONS:

7"H x 15"W x 7¾"D
(17.8cmH x 38.1cmW x 18.7cmD)

SHIPPING WEIGHT:

13 lbs (5.9kg)

FXi50

DRIVER COMPLEMENT:

6½"(16.5cm) drivers
2 - 1"(2.5cm) tweeter

OVERALL

FREQUENCY RESPONSE:

40Hz-27kHz

-3DB LIMITS:

50Hz-26kHz

RECOMMENDED

AMPLIFICATION:

10-150 watts/channel

EFFICIENCY (1M, 1W):

90dB

IMPEDANCE:

Compatible with 8 Ohm Outputs

CROSSOVER FREQUENCY:

2.5kHz

CROSSOVER SLOPE:

2nd Order HP,
2nd Order LP, selectable
Dipole/Bipole

ENCLOSURE TYPE:

Ported

DIMENSIONS:

14¾"H x 10¾"W x 9¼"D
(37.8cmH x 27.6cmW x 23.5cmD)

SHIPPING WEIGHT:

37 lbs (16.8kg)

FXi30

DRIVER COMPLEMENT:

5¼"(13.3cm) drivers
2 - 1"(2.5cm) tweeter

OVERALL

FREQUENCY RESPONSE:

50Hz-27kHz

-3DB LIMITS:

55Hz-26kHz

RECOMMENDED

AMPLIFICATION:

10-100 watts/channel

EFFICIENCY (1M, 1W):

89dB

IMPEDANCE:

Compatible with 8 Ohm Outputs

CROSSOVER FREQUENCY:

2.5kHz

CROSSOVER SLOPE:

2nd Order HP,
2nd Order LP, selectable
Dipole/Bipole

ENCLOSURE TYPE:

Ported

DIMENSIONS:

11½"H x 9"W x 8¼"D
(29.2cmH x 22.9cmW x 21cmD)

SHIPPING WEIGHT:

28 lbs (12.7kg)

polkaudio
the speaker specialists®

POLK AUDIO, INC. • 5601 METRO DRIVE, BALTIMORE, MD 21215 USA • 800.377.7655 • SALES DEPT. FAX: 410.764.5266
WWW.POLKAUDIO.COM



RM0307-1