

polk

USER MANUAL

MagniFi Max AX™

Setup	1
Product Features	10
Settings	16
Wi-Fi and Bluetooth®	23
Tips and Troubleshooting	28
Trademark Information	33

© Copyright 2022 Polk Audio, LLC.

Polk, Polk Audio, Polk MagniFi Max AX, Polk MagniFi Max AX SR, and Polk Voice Adjust are registered trademarks of Polk Audio, LLC. All other trademarks are the property of their respective owners.

Set Up the Sound Bar

Unpack

Check that the following items are included in the box.

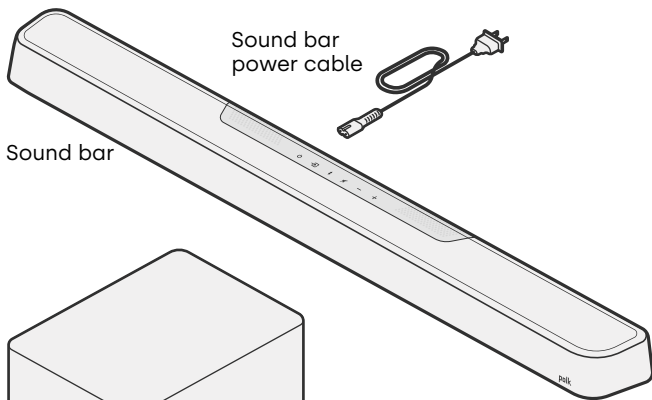

Sound bar
power cable

Sound bar

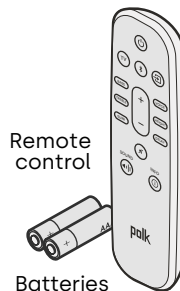

Remote
control

Batteries

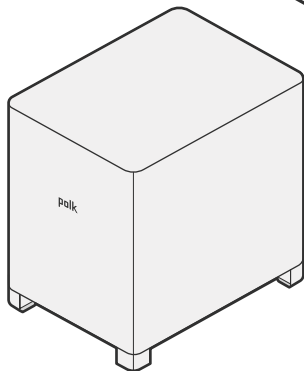

Subwoofer

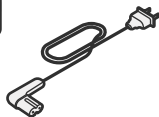

Subwoofer
power cable

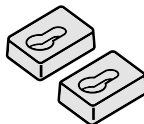

Wall mount
spacers

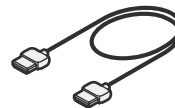

HDMI cable

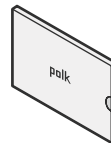

Literature pack

2

Place the sound bar

For the best listening experience, place the sound bar centered under your TV and flush with the front edge of your cabinet. If you would like to mount the sound bar to your wall, follow the instructions in the included wall-mount template.

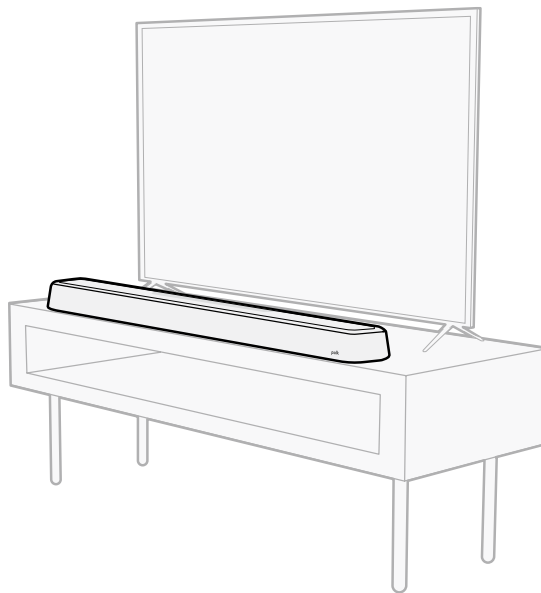

3 Connect your TV

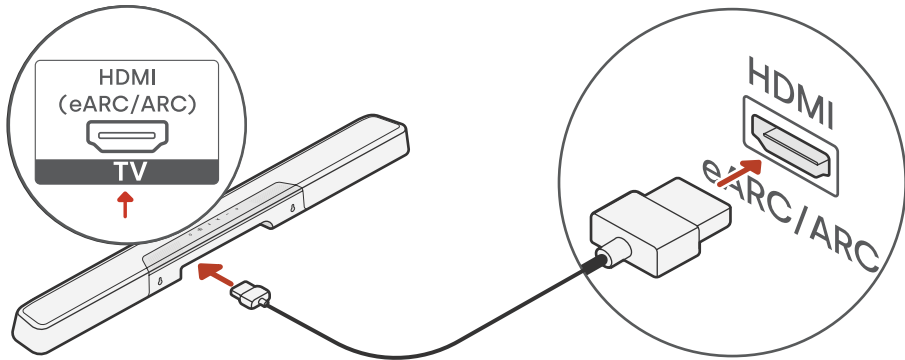

1. Look for the HDMI port on your TV labeled "ARC" or "eARC".
IMPORTANT: Only one port on your TV is labeled "ARC" or "eARC". You must connect to that specific port or else you will not hear TV audio.
2. Plug one end of the HDMI cable into the eARC/ARC port on the TV.
3. Plug the other end of the cable into the eARC/ARC port on the sound bar
4. (Optional): If you're using a Roku TV™, follow the on-screen instructions.

Note: If your TV does not have an HDMI port, you can connect the sound bar to your TV using an optical cable. However, please note that an optical connection does not support Roku TV Ready™ or Dolby Atmos® and DTS:X® audio formats.

4 Connect power

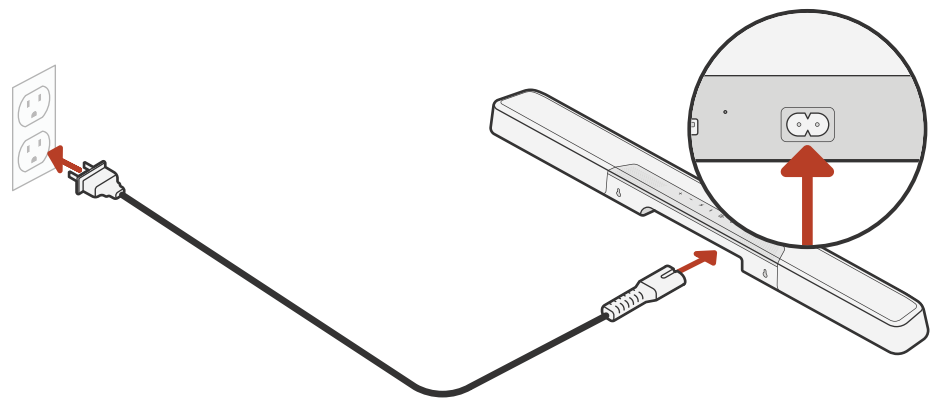

5

Set up the subwoofer

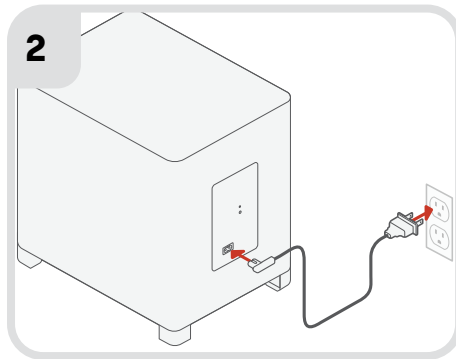
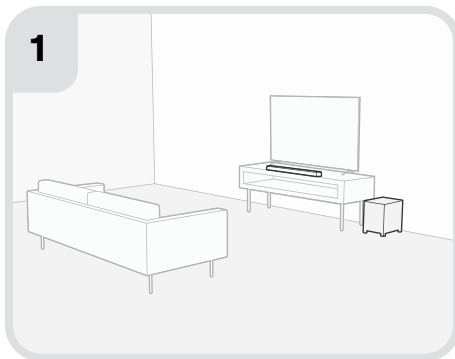

1. For best performance, place the subwoofer along the same wall as the TV and as close as possible to the TV. The distance between the sound bar and the subwoofer should not be more than 30ft (10m), with less distance preferred.
2. Connect the power cable to the subwoofer and to a wall outlet.

Note: The subwoofer automatically pairs to the sound bar when powered on, and connection to the sound bar is wireless.

6 Set up the remote

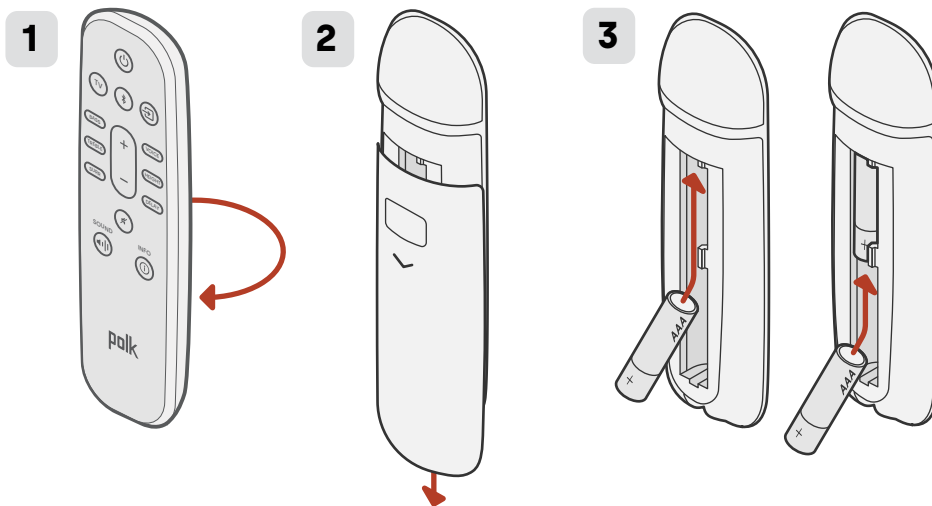

1. Turn the remote to view the back.
2. Open the back cover of the remote by sliding the bottom portion downward.
3. Insert the two AAA batteries into the remote and replace the cover.

7 Connect to Wi-Fi® via one of the three options below

Connect your sound bar to Wi-Fi® to complete setup and receive important software updates that will improve performance, enable new features, and maintain compatibility with your TV.

You can use one of three options to connect to Wi-Fi: the Google Home app, Amazon Alexa app, or directly from an iOS device.

Google Home app setup:

Download the free Google Home app on your Android or iOS device, then follow the instructions in the app to connect the sound bar to your Wi-Fi network.

Amazon Alexa app setup:

Download the free Amazon Alexa app on your Android or iOS device, then follow the instructions in the app to connect the sound bar to your Wi-Fi network.

Apple AirPlay setup:

1. Press and hold the power button on the top panel of the sound bar until you hear a beep and "WI-FI SETUP" displays on the sound bar.
2. Confirm that your iOS device is connected to the Wi-Fi network you want MagniFi Max AX to join.
3. On your iOS device, go to **Settings** > **Wi-Fi**.
4. Scroll down to SETUP NEW AIRPLAY SPEAKER, and tap **MagniFi Max AX-XXXX**.
5. Follow the on-screen instructions.

Setup is now complete!

Watch TV or play a movie and adjust the sound bar volume and other settings as desired.

You can use the sound bar top panel, the sound bar remote, or your TV remote to make adjustments to your listening experience. For more information, see pages 10-33.

If you do not hear any sound, or you hear an echo, see "Tips and Troubleshooting" on page 29.

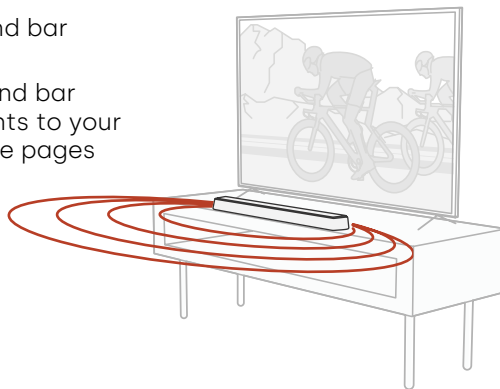

Need more help?

Watch the online setup video!

www.polkaudio.com/MagnifiMaxAX

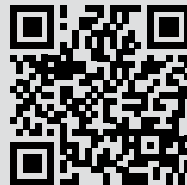

Product Features

Remote control features

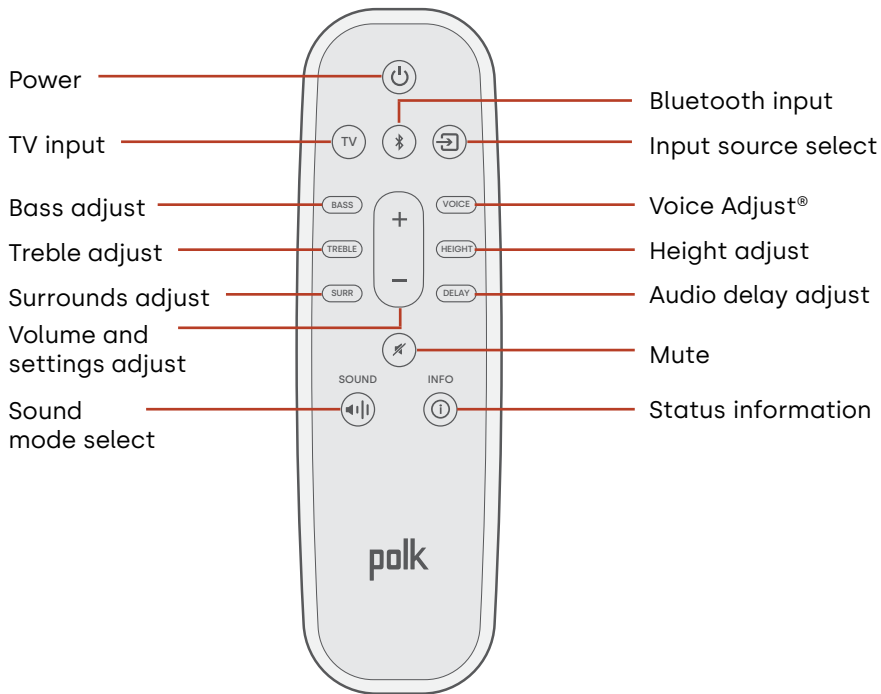

Sound bar features

Top panel

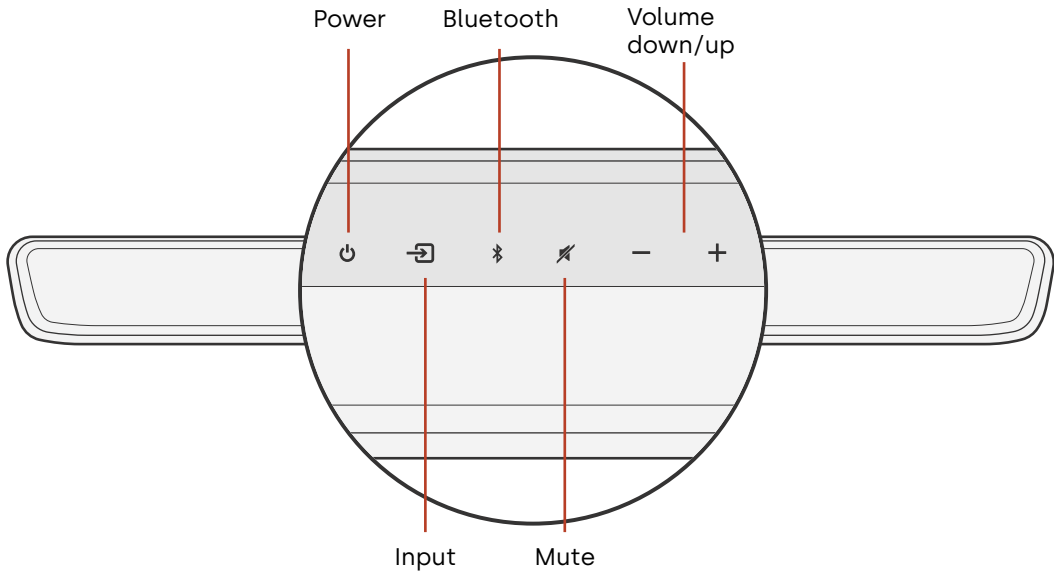

Front panel

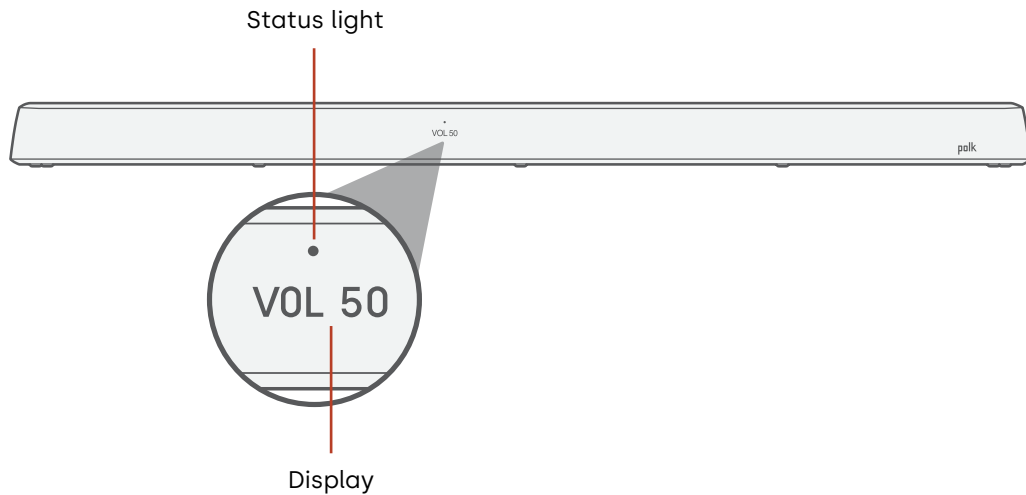

Back panel

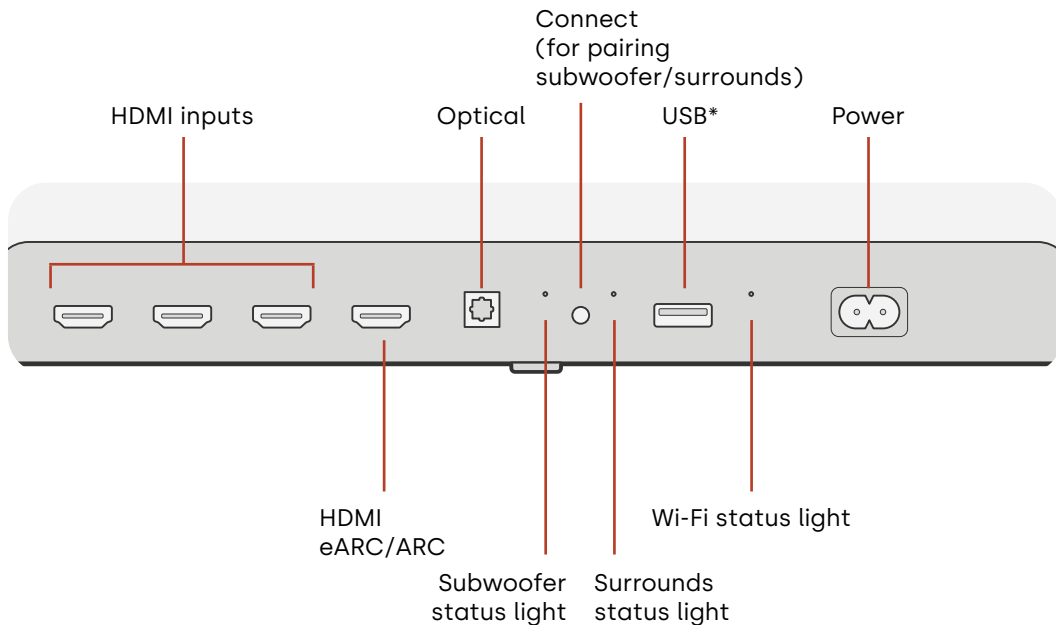

*For basic MP3 music playback (for more information, see page 33)

Subwoofer features

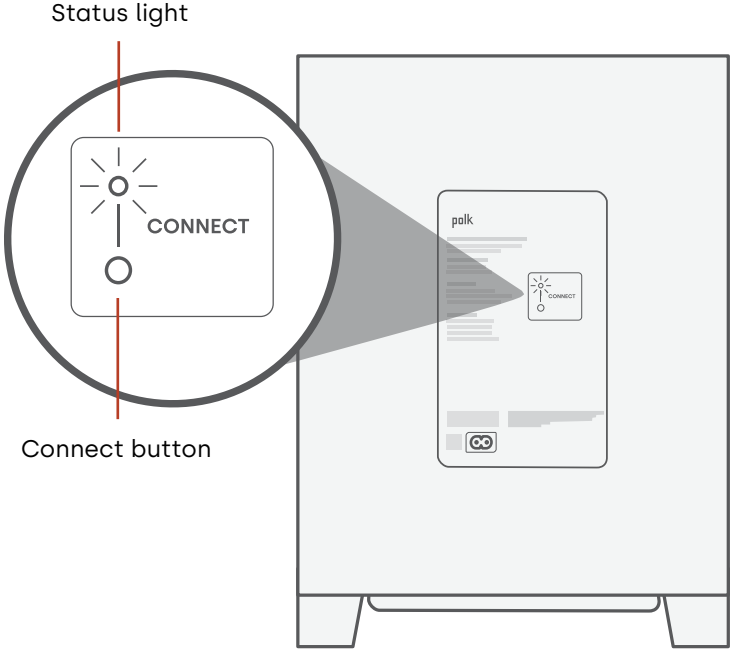

Settings

Status indicators

Display

The sound bar display provides status information when you change settings or modes. The display turns off when you are not actively changing settings or modes.

Press **i** on the remote at any time to view current settings on the display, including the input source, decoder, sound mode, and Wi-Fi, subwoofer, and surround speaker connection states.

Each button press shows the next status item in sequence.

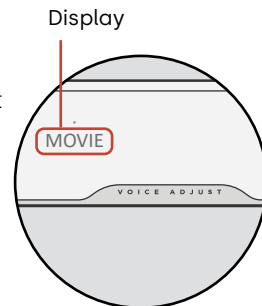

Status light

The status light above the display provides additional visual feedback regarding sound bar states. The light blinks when the bar is muted, booting up or updating software.

The status light can also indicate when the bar is powered on, if you enable this feature. To turn this feature on or off, press the

Mute  and **Volume Up**  buttons on the sound bar at the same time for 5 seconds.

When this feature is enabled, the status light is solid white when the bar is powered on. The status light turns off when the bar is in standby.

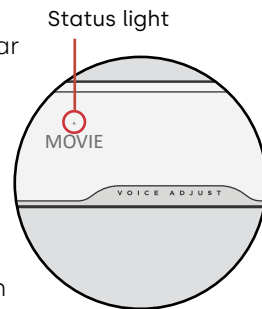

Customize your listening experience

Sound modes

Press **SOUND** on the remote to cycle through the available sound modes. The sound modes adjust the audio characteristics of the sound bar according to the type of content you're listening to.

Note: The sound mode is saved for each individual HDMI input to allow you to cater the sound for each of your source devices.

The sound bar display shows the current mode.

Auto Mode (Default)	Automatically sets the most appropriate sound mode for the media being played back.
TV Mode	Use this mode for casual TV and movie watching. This mode helps you hear all the important dialog and effects even at low to moderate volume levels.
Movie Mode	Use this mode for an enveloping and dynamic movie theater experience regardless of the content. This mode enhances the height and surround effects in Dolby Atmos® and DTS:X® audio formats and virtualizes these effects for other program formats. Turn up the volume and enjoy!

Night Mode	Use this mode for low-volume listening. This mode reduces bass and volume dynamics while improving voice intelligibility.
All Stereo Mode	Use this mode to send the front left and right channels to your surround speakers. This mode is only available when MagniFi Max AX Surrounds or Polk SR2 Wireless Surrounds are connected.
Music Mode	Use this mode for streaming music or for enhancing musical content in TV shows and movies.

Audio delay

If the sound bar audio is out of sync with the TV dialogue, you can manually adjust the timing using the audio delay adjustment feature.

To adjust audio delay:

1. Press **DELAY** on the remote to enter audio delay adjustment mode.
2. Use the **+** and **-** buttons to adjust the timing in small steps until the audio is in sync with the video. The sound bar display shows the current setting.
3. When finished, press the **DELAY** button again or wait 10 seconds to automatically exit audio delay adjustment mode.



Voice Adjust

For clearer, crisper dialogue, use the voice controls on the remote to isolate and adjust the dialogue level. Press the **VOICE** button and then **+** or **-** on the remote to increase or decrease the dialogue level on the sound bar.

Height adjust

Use the height-level control to increase or decrease the volume of the up-firing, height-channel speakers on your sound bar. This adjusts the overhead effects on the sound bar. Press the **HEIGHT** button and then + or – on the remote to increase or decrease the height-channel volume.

Treble adjust

Use the treble control to increase or decrease high-frequency details from your sound bar. Press the **TREBLE** button and then + or – on the remote to increase or decrease the treble on the sound bar.

Bass control

Use the bass controls on the remote to easily adjust bass volume. Press the **BASS** button and then + or – on the remote to increase or decrease the bass on the sound bar.

Surround control

Use the surround controls on the remote to easily adjust the volume on your connected surround speakers. Press the **SURR** button, then + for higher volume or – for lower volume.

If one surround speaker is too loud or the other is too quiet, you can use the remote to adjust the relative balance between the two speakers. To adjust the volume balance of the surround speakers: Press and hold the **SURR** button on the remote for 2 seconds, then press the + or – to change the relative volume between the two speakers.

Note: You must have a pair of MagniFi Max AX Wireless Surrounds or Polk SR2 Wireless Surrounds connected to your sound bar in order to use this feature.

Use your TV remote to control the sound bar

You can also use your TV, cable, or satellite remote to control the sound bar power, volume, mute and other functions. Depending on your TV model and connection type, you might need to teach the sound bar to respond to your TV remote.

If the sound bar does not respond to your TV, cable or satellite remote, follow the steps below.

Teach the sound bar to respond to your TV remote

Important: For best results, install fresh batteries in the Polk remote and your TV remote and point both remotes at the sound bar front panel from 1-3 ft (30-90 cm) away.

1. Enter Remote Control Learning mode.

On the sound bar top panel, press and hold the **Source** button (↵) for about 3 seconds. Release the button when "REMOTE LEARN" appears on the front panel display.

The prompt "POLK REMOTE" appears on the display.

2. Select a button on the Polk remote.

Press and release a button that you want the sound bar to learn (for example, **Volume Up**).

The prompt "TV REMOTE" appears on the display.

3. Select a button on your TV remote.

Press and release the button on your TV remote that you want to control the sound bar function you selected in step 2 (for example, **Volume Up**).

If the message "TRY AGAIN" appears on the display, repeat steps 2 and 3.

The message "SUCCESS" appears on the display when the command is successfully programmed.

4. Repeat steps 2 and 3 to program other buttons.

5. Exit Remote Control Learning mode.

Press and hold the **Source** button (↵) until "EXIT" appears on the display.

Clear learned TV remote control codes

Press and hold the **Source** button (↵) on the sound bar for about 10 seconds. You will hear a two-note tone. Continue holding the button and release the button after you hear a three-note tone. The message "IR CLEARED" appears on the sound bar.

Wi-Fi and Bluetooth®

Listen with Chromecast built-in™

With Chromecast built-in, you can easily:

- Stream music from your favorite apps over Wi-Fi.
- Create a whole-home audio experience. Multi-room sync lets you play the same song across multiple Chromecast built-in compatible speakers in your house at the same time.
- Stream media to the sound bar from any Google Assistant-enabled speaker. Use voice commands to play your favorite content, change volume, and get information about what you are listening to.
- Receive automatic updates.

To set up Chromecast:

1. Confirm that your Android or iOS device is connected to the Wi-Fi network that you want MagniFi Max AX to join.
2. Download the free Google Home app on your Android or iOS device.
3. Follow the instructions in the app to connect the sound bar to your Wi-Fi network.

For more information about Google Home and Chromecast built-in for audio, visit support.google.com/googlenest and support.google.com/chromecastbuiltin.



Listen with Apple AirPlay®

AirPlay® is an Apple technology designed to control home audio systems and speakers in any room – with a tap or by just asking Siri – right from iPhone®, iPad®, HomePod®, or Apple TV®.

Play a song in the living room and kitchen at the same time or adjust the volume in any room, all in sync.

To set up Apple AirPlay (if Chromecast isn't already set up):

1. Press and hold the power button on the top panel of the sound bar until you hear a beep and "WI-FI SETUP" displays on the sound bar.
2. Confirm that your iOS device (iPhone or iPad) is connected to the Wi-Fi network you want MagniFi Max AX to join.
3. On your iOS device, go to **Settings > Wi-Fi**.
4. Scroll down to SETUP NEW AIRPLAY SPEAKER, and tap **MagniFi Max AX-XXXX**.
5. Follow the on-screen instructions.

Note: If you already set up Chromecast, then AirPlay is ready to use. Tap the AirPlay icon in your favorite music app, then tap **MagniFi Max AX**.



Listen with Amazon Alexa™

Connect the MagniFi Max AX to your Alexa account, and use your existing Amazon Alexa Built-in or Echo device(s) to play music (including multi-room music), adjust volume, set alarms, and more.

Set up with the Alexa app

Download the Alexa app on your mobile device. Once you reach the Home screen in the Alexa app, a prompt appears and guides you through the setup process.

Note: If a prompt doesn't appear, manually add the MagniFi Max AX to the Alexa app.

After setup is complete

- Use voice commands on a nearby Amazon Alexa Built-in or Echo device to control the sound bar.
- Play music directly to the sound bar in just a few taps in the Amazon Music, Amazon Alexa, and Spotify apps.
- Automatically receive important software updates on the sound bar.



Listen to music with Bluetooth®

Connect a phone or tablet with Bluetooth

1. Press the **Bluetooth** button on the top panel of the sound bar or on the remote. "BT READY TO PAIR" appears on the sound bar display.
2. Navigate to the Bluetooth settings in your phone or tablet, and select "Polk MagniFi Max AX".
"BT CONNECTED" appears on the sound bar display when your phone or tablet connects to the sound bar.

Note: If a Bluetooth device is already connected, you will not be able to pair a new device until you disconnect the other device.

Automatic reconnect

When you press the **Bluetooth** button on the top panel of the sound bar, the sound bar attempts to automatically reconnect to the Bluetooth device that was most recently connected.

Disconnect a Bluetooth device

You can disconnect from Bluetooth in your phone or tablet Bluetooth settings. Alternatively, press and hold the **Bluetooth** button on the top panel of the sound bar for three seconds. After disconnecting, the sound bar enters pairing mode, and "BT READY TO PAIR" appears on the sound bar display.

Tips and Troubleshooting

I don't have an HDMI port labeled "eARC" or "ARC" on my TV.

1. Use an optical cable to connect the sound bar to your TV.
2. Turn off your TV's internal speakers. See your TV manual for instructions.

There is no sound coming from my sound bar.

- Check that the sound bar is powered on.
- Check that all cables are connected correctly.
- Press the **Volume up** button on the sound bar top panel to increase the volume.

There is no sound coming from my subwoofer.

- Check that the sound bar is powered on and playing audio.
- Check that the "SUB" status light on the back panel of the sound bar is green.
- Check that the status light on the back panel of the subwoofer is green.
- Turn up the bass using the Polk remote.
- Check that the power cable is secure in the subwoofer and in the wall outlet.
- Unplug the subwoofer for 30 seconds, and then plug it back in.

I hear an echo from my TV or sound bar.

- Check that the TV's internal speakers are disabled. Refer to your TV manual.
- If your TV is connected to the sound bar via HDMI ARC, check that HDMI CEC/ARC is enabled in your TV's Settings menu.

My remote control isn't working.

- Get closer to the sound bar and aim the remote at the front of the sound bar.
- Make sure nothing is blocking the IR receiver on your TV (the part of your TV where you aim the remote).
- Make sure the batteries are installed in the correct direction.
- Install fresh batteries in the remote.
- To teach your TV, cable, or satellite remote to control the sound bar, see "Use your TV remote to control the sound bar" on page 20.

How do I perform a factory reset?

Note: A reset will erase all sound bar settings, including Bluetooth and Wi-Fi settings.

With the sound bar turned on, press and hold the **Power** button (⏻) and the **Mute** button (🔇) on the top panel of the sound bar for 7 seconds. You will see numbers countdown on the display, followed by "RESET" and a chime. The bar restarts when the process is complete.



How do I wirelessly connect (pair) my subwoofer or surround speakers?

1. Plug in your subwoofer and/or surround speakers and make sure the sound bar is powered on.
2. Enter pairing mode on the sound bar by pressing and holding the **CONNECT** button on the back panel of the sound bar for about 3 seconds. You will hear a confirmation tone.
3. On the subwoofer or surround speaker, press the **CONNECT** button on the back panel for about 3 seconds until you hear a confirmation tone.
4. Repeat step 3 for other speakers that need to be paired.
5. When finished, press the **CONNECT** button on the sound bar to save the new pairings and exit pairing mode.

Why do I see a network called Polk MagniFi Max AX?

Your soundbar broadcasts a wireless network so that you can connect the soundbar to Wi-Fi. The wireless network signal turns off once you complete Wi-Fi set up. We recommend connecting your sound bar to the internet to receive the latest software updates. For more information, see “Wi-Fi and Bluetooth” on pages 21-25. You can also completely disable Wi-Fi if you don’t want to connect the soundbar to the internet.

How do I disable Wi-Fi?

To completely disable Wi-Fi, press and hold the **Mute** button () and the **Source** button () button on the top panel of the sound bar for 5 seconds. To enable Wi-Fi again, repeat the procedure.

Note: If you already connected your sound bar to a Wi-Fi network, disabling Wi-Fi does NOT clear connection settings. To clear all connection settings and account information, see “How do I perform a factory reset?” on page 31.

My sound bar randomly powers on by itself.

Your sound bar is preset to automatically power on when you use a device that is connected to the sound bar. To disable automatic power on for an input:

1. Press the desired input on the Polk remote control.
2. Press and hold the desired input button on the Polk remote control for 5 seconds.

My sound bar randomly powers off by itself.

Your sound bar is preset to automatically power off after 20 minutes of inactivity.

To disable automatic power off, press and hold the **Power** button () and **Volume Down** button on the top panel of the sound bar for 5 seconds.

Can I put the sound bar into sleep mode?

You can use Vacation Mode to put your sound bar into a deep sleep. To enter Vacation Mode, press and hold the Mute button and Volume Down button on the top panel of the sound bar for 10 seconds. To take the sound bar out of Vacation Mode, press any button on the sound bar.

Can I play music on the sound bar via a USB flash drive?

Yes. You can plug a USB Type-A flash drive into the USB port on the back panel of the sound bar for MP3 music playback. The MP3 music files must be on the root of the flash drive. The songs will play automatically when you plug in the flash drive.

Note: There are no controls to navigate through music tracks on the flash drive.

Trademark Information

 **Dolby Atmos**

COMPATIBLE WITH

 **Dolby Vision**

Dolby, Dolby Vision, Dolby Atmos, and the double-D symbol are registered trademarks of Dolby Laboratories Licensing Corporation. Manufactured under license from Dolby Laboratories. Copyright © 2012-2021 Dolby Laboratories. All rights reserved.

HIGH DEFINITION MULTIMEDIA INTERFACE

The terms HDMI, HDMI High-Definition Multimedia Interface, and the HDMI Logo are trademarks or registered trademarks of HDMI Licensing Administrator, Inc.



For DTS patents, see <http://patents.dts.com>. Manufactured under license from DTS, Inc. DTS, DTS:X, Virtual:X, and the DTS:X logo are registered trademarks or trademarks of DTS, Inc. in the United States and other countries. © 2020 DTS, Inc. ALL RIGHTS RESERVED.



Apple, AirPlay, iPhone, iPad, HomePod, and AppleTV are trademarks of Apple Inc., registered in the U.S. and other countries. Use of the Works with Apple badge means that an accessory has been designed to work specifically with the technology identified in the badge and has been certified by the developer to meet Apple performance standards.



The Wi-Fi CERTIFIED logo is a registered trademark of the Wi-Fi Alliance. Wi-Fi Certification provides assurance that the device has passed the interoperability test conducted by the Wi-Fi Alliance, a group that certifies interoperability among wireless LAN devices.



The Bluetooth word mark and logos are registered trademarks owned by the Bluetooth SIG, Inc. and any use of such marks by Polk Audio is under license.



Google, Google Home, and Chromecast built-in are trademarks of Google LLC.



Roku, the Roku logo, Roku TV, Roku TV Ready, and the Roku TV Ready logo are trademarks and/or registered trademarks of Roku, Inc. This product is Roku TV Ready-supported in the United States, Canada, Mexico and the United Kingdom. Countries are subject to change. For the most current list of countries in which this product is Roku TV Ready-supported, please email rokutvready@roku.com.



Spotify is all the music you'll ever need. Millions of songs available instantly. Just search for the music you love, or let Spotify play you something great. Spotify works on your phone, tablet, computer, and home speakers. So you'll always have the perfect soundtrack for whatever you're doing. Now you can enjoy Spotify with your free account as well as Premium account. Use your phone, tablet or computer as a remote control for Spotify.

Go to www.spotify.com/connect to learn how.

The Spotify software is subject to third-party licenses found here: www.spotify.com/connect/third-party/licenses.



Amazon, Alexa and all related logos are trademarks of Amazon.com, Inc. or its affiliates.

GREAT SOUND FOR ALL™

Share Photos | Partager Des Photos | Compartir Fotos



#PolkAudio

Sound United, LLC
5541 Fermi Court
Carlsbad, CA 92008
U.S.A.

EU Contact:
Sound United Europe,
A division of D&M Europe B.V.
Beemdstraat 11, 5653 MA
Eindhoven, The Netherlands

UK Importer:
D&M Audiovisual Ltd
Dale Road, Worthing,
West Sussex
BN11 2BH United Kingdom